

E A S Y W O O D

**GLUED LAMINATED
TIMBER**

Mežrūpnieku iela 6a
Jēkabpils, Latvija
www.easywood.lv

GLUED LAMINATED TIMBER

OVERVIEW

PRODUCTION STANDARTS

EN 14080

SURFACE QUALITY

Visible quality

Industrial quality

STRENGTH CLASS

GL24h

WOOD SPECIES

Spruce

Pine

Other types of wood on request

DIMENSIONS AND STEPS

Widths: 60 to 240 mm (20 mm step)

Heights: 80 to 1500 mm (20 mm step)

Lengths: up to 15 m



QUALITY STANDARDS

GENERAL PROPERTIES

Suitable for:

INDUSTRIAL

For use in non-visible areas such as roof structures, substructures, production buildings, industrial halls, etc.

VISIBLE

For use in visible area such as living areas, roofs, walls, ceilings, etc.

Black knots:

Allowed.

Allowed if not separaiting.

Splits:

Allowed (up to 1/7 of the element width), but the static load requirements cannot be compromised.

Not allowed.

Decrease, Rot, Insects:

Not allowed.

Not allowed.

Blue stain:

Allowed up to 5% of the element.

Not allowed.

Visible marks:

Rough marks are allowed.

Rough marks are not allowed, small markings may occur.

GLUED LAMINATED TIMBER PANELS

OVERVIEW

PRODUCTION STANDARTS

EN 14080

SURFACE QUALITY

Visible quality

Industrial quality

STRENGTH CLASS

GL 24h in accordance to EN 14080

WOOD SPECIES

Spruce

DIMENSIONS AND STEPS

Widths: 60 to 240 mm (20 mm step)

Heights: 360 to 760 mm (40 mm step)

Lengths: up to 15 m



TECHNICAL DATA

Glue:	Melamine resin adhesive
Moisture content:	12% ± 2%
Density:	420 kg/m ³ to 500 kg/m ³ in average
Thermal conductivity value:	$\lambda = 0.13 \text{ W/mK}$
Diffusion resistance:	$m = 40$
Fire Resistance:	0.65 mm/min
Shrinkage and swelling:	perpendicular to the fibre - $\alpha_{u,90} = 0.24\%$ per 1% change in moisture content
Fire behaviour:	D-s2, d0 D _{fl} -s1 used in floor covering
Lamella thickness:	Up to 45 mm

ADVANTAGES

- Easy assembly
- Self-weight is lower than reinforced concrete
- High degree of prefabrication
- Loads are applicable immediately after assembly
- High fire resistance
- No additional moisture is produced during installation
- Cutouts and openings are simple and accurately incorporated on-site
- Work can take place regardless of weather conditions

APPLICATIONS

Glued Laminated Timber (GLT) Panels are ideally for use as floor, ceiling, roof and wall elements in solid wood construction, frame construction, skeleton construction, and in combination with stone construction.

ENVIRONMENTAL MATERIAL

Timber requires the least energy for processing, non competing building material is produced, processed and used with so little total application of energy as wood. As a building material in solid construction, this differentiates glued laminated timber fundamentally from competing building materials, which require extensive energy to produce and have no benefits in terms of environmental balance.

Wood can give a building an active climate protection. It takes up to 1.9 tonnes of CO₂ in 1t of wood, meaning that 500 kg of carbon is stored in the wood.

ACOUSTIC PANELS

FOR USE IN

Public buildings, auditoriums, offices, rehearsal rooms, gyms, schools

SOUND ABSORPTION

$$\alpha_w = 0.10$$



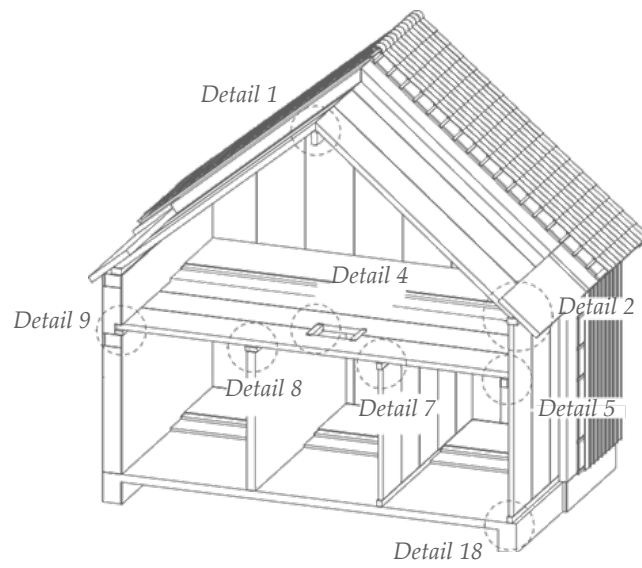

DETAIL FIGURES CAN BE FOUND
IN THE INDIVIDUAL AREAS
ROOF | FLOOR | WALL

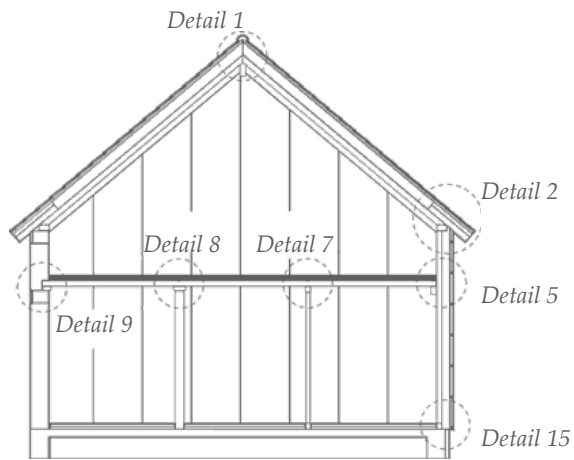

CROSS SECTION A - A

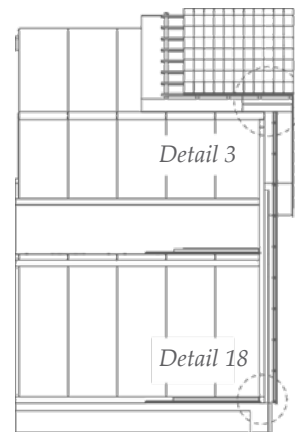

CROSS SECTION A - A

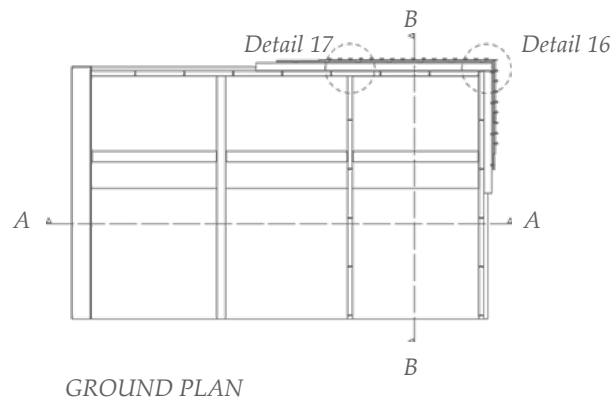

GROUND PLAN

GLULAM TIMBER PANELS ROOF

Glulam timber panels replace rafters, purlins and boarding in the roof area while also featuring much smaller unit heights. Insulation and the sarking membrane are laid without interruption on a flat surface. This has clear advantages for the building's physical properties.

STRUCTURAL ANALYSIS

The design loads are determined according to DIN 1055. The following preliminary calculation assumes the following values for dead loads:

- | | |
|--|-------------------------------|
| • Roofing (roof tiles): | 0.55 kN/m ² |
| • Insulation (soft wood fibre) t = 16 cm: | 0.15 kN/m ² |
| • Sarking membrane: | 0.05 kN/m ² |
| • Glulam element (dead weight = 0.45 kN/m ³) | 0.30 - 1.20 kN/m ² |
-
- | | |
|----------------------------------|----------------------------------|
| • Dead load | $g = 1.05 - 1.95 \text{ kN/m}^2$ |
| • Snow load (location-dependant) | $s = 0.75 \text{ kN/m}^2$ |

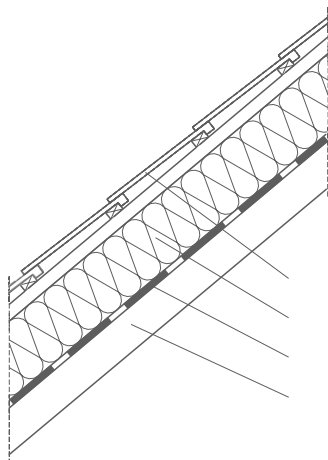

Roofing
Insulation
Vapour-permeable sealing layer
Easywood Roof Panel

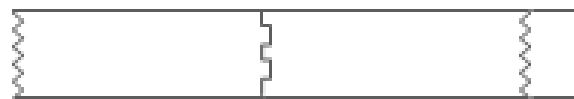

Easywood Roof Panels

This roof structure and a glulam element thickness of 14 cm yields a U-value of 0.23 W/m²K.



ROOF PANELS

DIMENSIONING TABLE FOR ROOF PANELS

The following parameters were used:

Roof incline	$\alpha = 40^\circ$
Eaves height	ht = 3.50 m
Deflection limit	1/400
Single-span beam	

Minimum Roof Panel Thickness	Max. Span Width (basic length)
60 mm	1,90 m
80 mm	2,70 m
100 mm	3,40 m
120 mm	4,00 m
140 mm	4,60 m
160 mm	5,20 m
180 mm	5,70 m
200 mm	6,20 m
220 mm	6,70 m
240 mm	7,20 m

COST OVERVIEW

Glulam roof elements are an alternative to classic roof trusses produced through typical carpentry. Visible rafters and boarding are replaced by glulam elements. Their vapour-permeable structure produces a comfortable living climate. Summer heat protection is built-in thanks to the wood mass.

The cost overview represents a cost estimate. You should obtain a detailed offer. In addition, the thermal insulation, sealing layer and roofing must also be calculated into the price.

EASYWOOD ROOF PANELS

Material costs for glulam roof panels $t = 10$ cm:

Material costs for shaped sheet metal parts, screws, etc.:

Assembly / trimming costs for glulam roof panels:

EASYWOOD ROOF PANELS

RIDGE BEAM

DETAIL 1

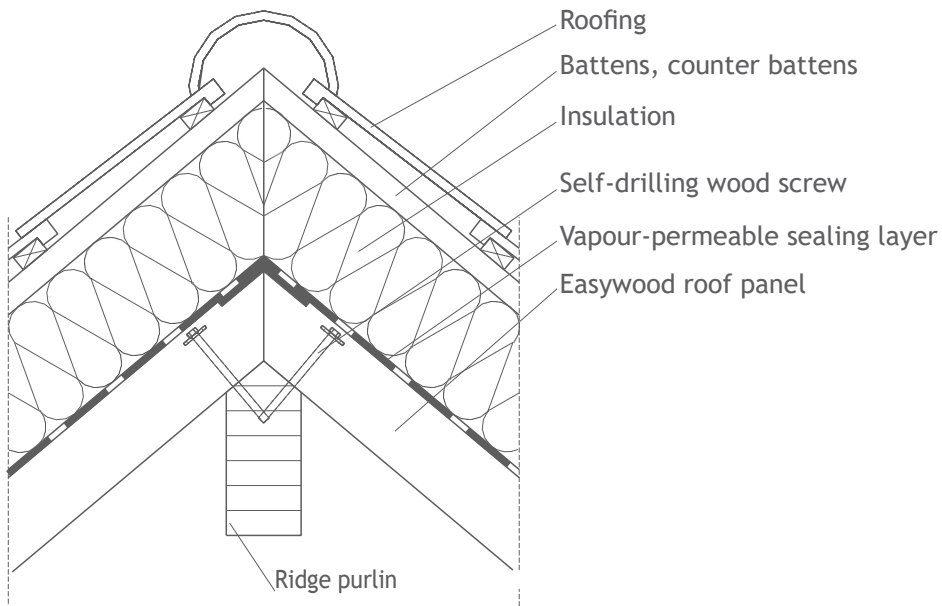

EAVES

DETAIL 2

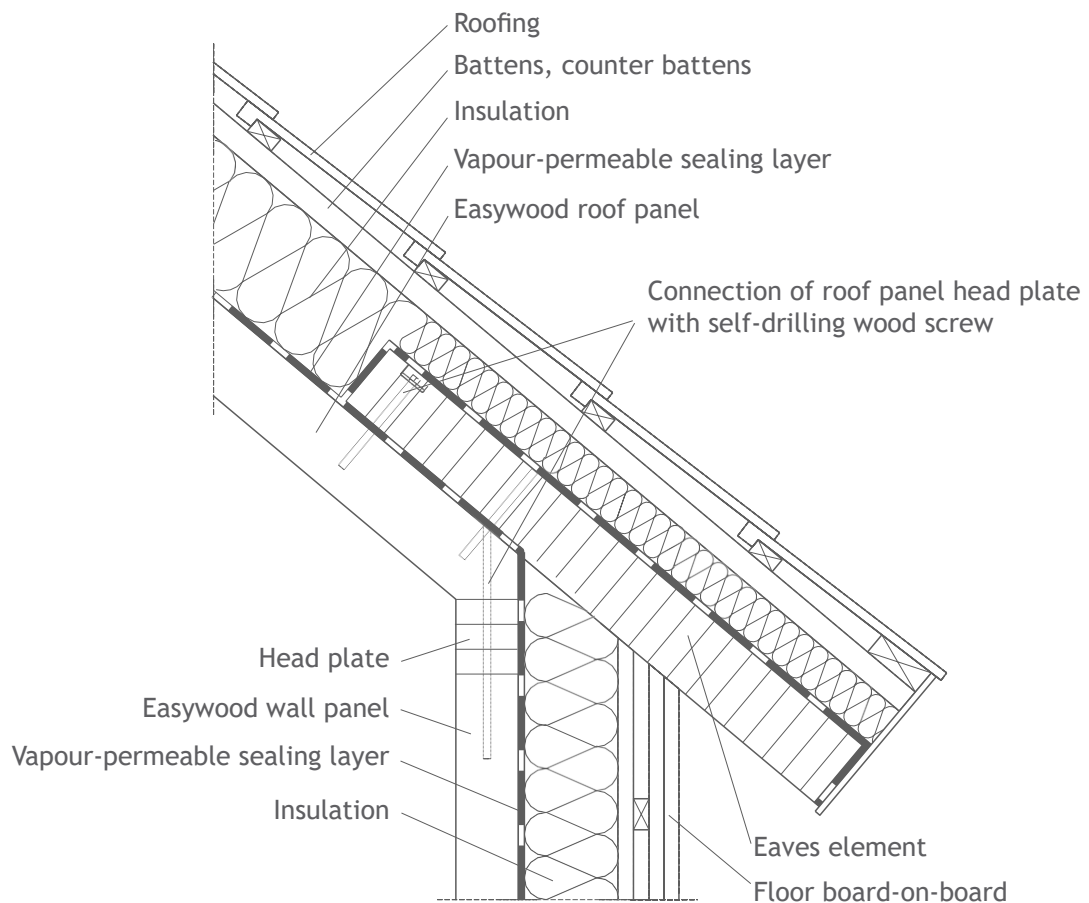

EASYWOOD ROOF PANELS

VERGE FLASHING

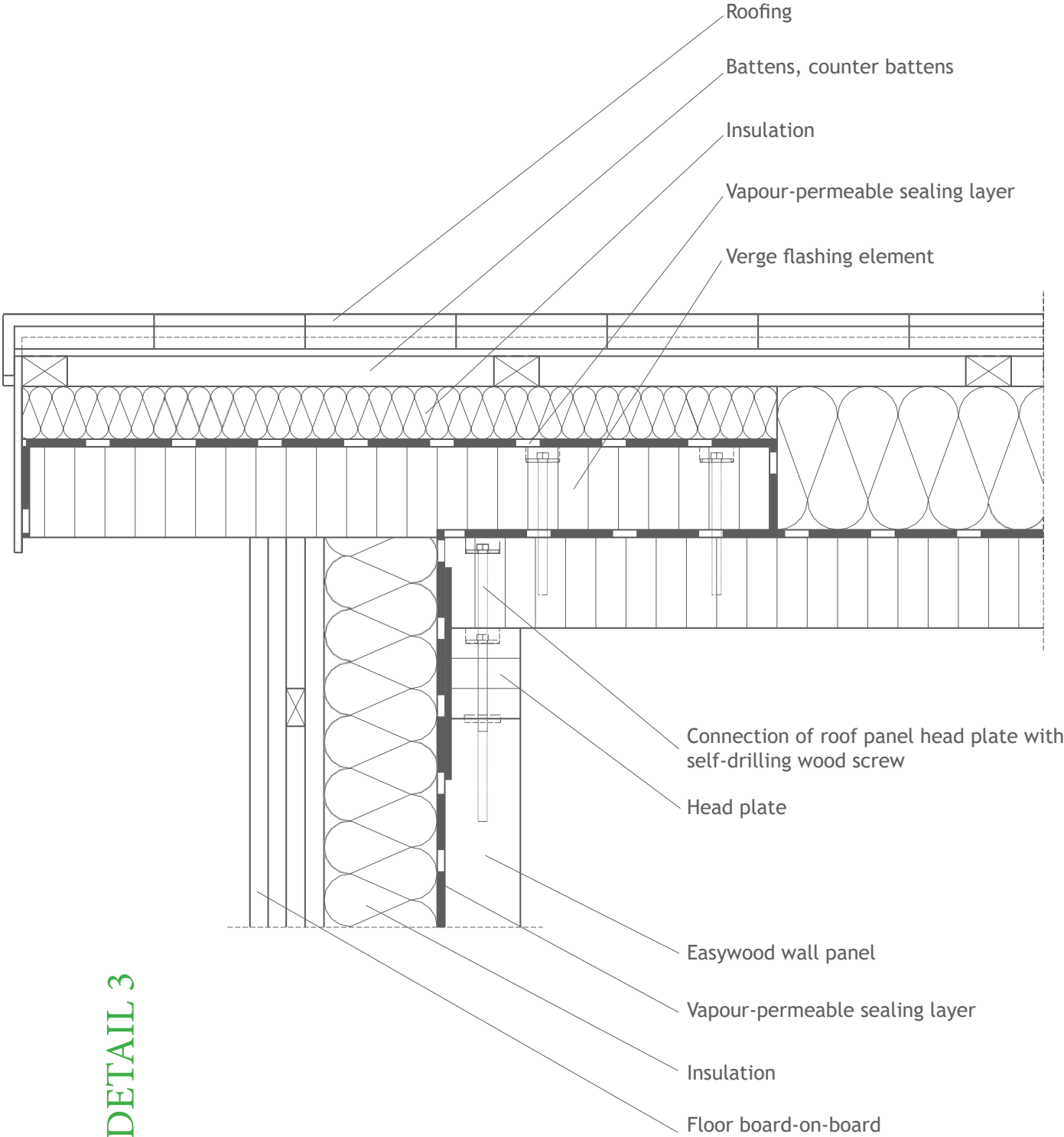

DETAIL 3

GLULAM TIMBER PANELS FLOOR

Simple and economical floor structures can be built with glulam timber panels. In new buildings, low-height structures that can bridge large span widths and are immediately capable of bearing weight can be created in a very short time. No additional moisture is produced during installation. Subsequent work can be performed immediately. Freedom of movement is ensured within the rooms below. For renovation work and adding additional floors, glulam timber panels can be used to good advantage. Existing structures, such as floors or roofs can be bridged over and therefore retained.

IMPACT SOUND VALUES

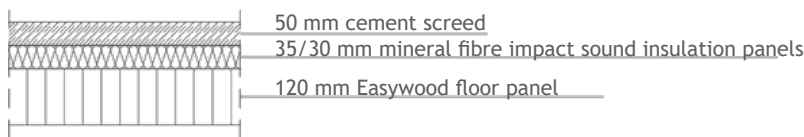

Floor structure 1: Rated standard impact sound level $L'_{n,w} = 66$ dB

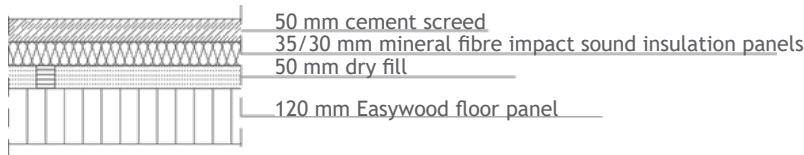

Floor structure 2: Rated standard impact sound level $L'_{n,w} = 51$ dB

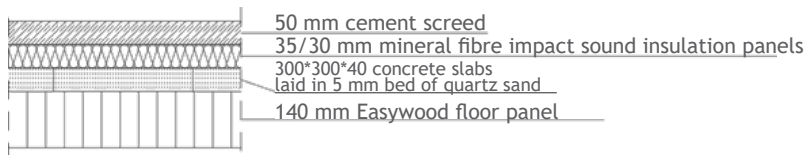

Floor structure 3: Rated standard impact sound level $L'_{n,w} = 52$ dB

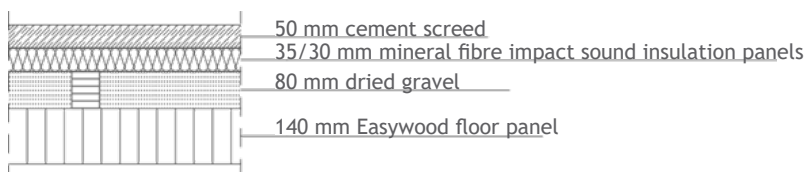

Floor structure 4: Rated standard impact sound level $L'_{n,w} = 46$ dB

DIMENSIONING FOR FLOOR PANELS

For purposes of preliminary dimensioning, the vibration can be taken into account with a deflection limit of 1/450.

This corresponds roughly to the approach: 30% traffic load + 100% constant load = maximum 6 mm deflection.

These preliminary dimensioning tables do not replace the structural analysis; they serve only as an aid to calculation. Creepage and shrinkage as well as the dead weight of the glulam timber panels are taken into account in the preliminary dimensioning in our dimensioning tables. The assumed maximum share of the constant load in the additional surface load is 3.0 kN/m².

VIBRATION INFLUENCE ACCOUNTED FOR

Creepage and shrinking as well as the dead weight of the glulam timber elements are taken into account.

ADDITIONAL SURFACE LOAD PER m²

Panel Thickness	2.0 kN/m ²	2.5 kN/m ²	3.0 kN/m ²	3.5 kN/m ²	4.0 kN/m ²	4.5 kN/m ²	5.0 kN/m ²	5.5 kN/m ²	6.0 kN/m ²	6.5 kN/m ²	7.0 kN/m ²	7.5 kN/m ²	8.0 kN/m ²
60mm	2.15m	2.05m	1.90m	1.75m	1.65m	1.60m	1.55m	1.50m	1.45m	1.40m	1.35m	1.30m	1.25m
80mm	2.85m	2.70m	2.55m	2.40m	2.30m	2.20m	2.10m	2.00m	1.95m	1.90m	1.85m	1.80m	1.75m
100mm	3.50m	3.35m	3.20m	3.05m	2.90m	2.75m	2.65m	2.60m	2.55m	2.50m	2.45m	2.40m	2.35m
120mm	4.10m	3.90m	3.80m	3.60m	3.45m	3.30m	3.20m	3.15m	3.10m	3.05m	3.00m	2.95m	2.90m
140mm	4.70m	4.55m	4.40m	4.20m	4.00m	3.85m	3.75m	3.65m	3.55m	3.45m	3.40m	3.35m	3.30m
160mm	5.30m	5.15m	5.00m	4.70m	4.50m	4.40m	4.30m	4.15m	4.05m	3.95m	3.85m	3.80m	3.75m
180mm	5.90m	5.75m	5.60m	5.25m	5.05m	4.90m	4.80m	4.65m	4.55m	4.45m	4.35m	4.25m	4.20m
200mm	6.50m	6.30m	6.15m	5.80m	5.60m	5.45m	5.30m	5.10m	5.00m	4.90m	4.80m	4.70m	4.65m
220mm	7.00m	6.85m	6.65m	6.30m	6.05m	5.90m	5.80m	5.60m	5.50m	5.40m	5.25m	5.20m	5.15m
240mm	7.50m	7.35m	7.20m	6.80m	6.55m	6.40m	6.25m	6.05m	5.95m	5.85m	5.75m	5.70m	5.60m

VIBRATION INFLUENCE NOT ACCOUNTED FOR (DEFLECTION LIMIT 1/300)

Creepage and shrinking as well as the dead weight of the glulam timber elements are taken into account.

ADDITIONAL SURFACE LOAD PER m²

Panel Thickness	2.0 kN/m ²	2.5 kN/m ²	3.0 kN/m ²	3.5 kN/m ²	4.0 kN/m ²	4.5 kN/m ²	5.0 kN/m ²	5.5 kN/m ²	6.0 kN/m ²	6.5 kN/m ²	7.0 kN/m ²	7.5 kN/m ²	8.0 kN/m ²
60mm	2.50m	2.35m	2.20m	2.05m	1.95m	1.85m	1.80m	1.75m	1.70m	1.65m	1.60m	1.55m	1.50m
80mm	3.15m	3.10m	3.00m	2.85m	2.70m	2.55m	2.45m	2.40m	2.35m	2.30m	2.25m	2.20m	2.15m
100mm	4.00m	3.85m	3.70m	3.50m	3.30m	3.10m	3.00m	2.95m	2.90m	2.85m	2.80m	2.75m	2.70m
120mm	4.70m	4.55m	4.40m	4.15m	4.00m	3.80m	3.70m	3.60m	3.50m	3.40m	3.35m	3.30m	3.25m
140mm	5.40m	5.25m	5.10m	4.85m	4.70m	4.40m	4.30m	4.20m	4.10m	4.00m	3.95m	3.90m	3.85m
160mm	6.10m	5.95m	5.75m	5.45m	5.20m	4.95m	4.80m	4.70m	4.60m	4.50m	4.45m	4.40m	4.35m
180mm	6.80m	6.55m	6.40m	6.10m	5.80m	5.55m	5.45m	5.35m	5.20m	5.10m	5.05m	4.95m	4.85m
200mm	7.40m	7.20m	7.00m	6.70m	6.35m	6.05m	5.95m	5.85m	5.75m	5.65m	5.55m	5.45m	5.40m
220mm	8.00m	7.80m	7.60m	7.30m	6.90m	6.65m	6.55m	6.45m	6.25m	6.10m	6.00m	5.95m	5.90m
240mm	8.65m	8.45m	8.25m	7.75m	7.50m	7.25m	7.10m	7.00m	6.80m	6.65m	6.60m	6.50m	6.45m

VIBRATIONS

Floor vibrations in the non-audible, low-frequency ranges are a problem. These vibrations are perceived as unpleasant by many people. We have integrated the vibration behaviour into our dimensioning tables.

DIMENSIONING EXAMPLE

With consideration of vibrations, the floor typically has a thickness of: $t = 16 \text{ cm}$

<i>Floor dimensions:</i>	$l = 4,50 \text{ m}$ (open span) $b = 4,00 \text{ m}$ (width of the floor panel)
<i>Floor thickness:</i>	$d = 16 \text{ cm}$
<i>Loads:</i>	$eg = 1,95 \text{ kN / m}^2$ (dead weight) $p = 2,00 \text{ kN / m}^2$ (traffic load) $\bar{m} = 100 \times pd = 100 \times (1,95 + 0,3 \times 2,00) = 255 \text{ kg/m}^2$
<i>Longitudinal beam (ceiling panel):</i>	$h = 0,16 \text{ m}$ $E = 11.000 \text{ MN/m}^2$ $(EI) l = 11.000 \times 0,162/12 = 3,75 \text{ MNm}^2/\text{m}$
<i>Transverse beam (screed):</i>	$h = 0,05 \text{ m}$ $E = 26.000 \text{ MN/m}^2$ $(EI) b = 26.000 \times 0,052 /12 = 0,2708 \text{ MNm}^2/\text{m}$

VERTIFICATION BASED ON THE FREQUENCY CRITERION:

$$f = \pi / (2 \times l^2) \times (\sqrt{ ((EI)_l / m) }) \times (\sqrt{ (1 + ((EI)_b \times l^4) / ((EI)_l \times b^4)) })$$
$$f = \pi / (2 \times 4.5^2) \times (\sqrt{ ((3.75 \times 10^6) / 255) }) \times (\sqrt{ (1 + ((0.2708 / 3.75) \times (4.5^4 / 4^4))) })$$
$$= 0.07757 \times 121.267 \times 1,056$$
$$= 9.936 \text{ Hz} > 8 \text{ Hz} = \text{positive verification}$$

ASSEMBLY OF THE PANELS AS A FLOOR SLAB

Assembly of the floor elements as a slab presents no difficulties if the extent of recesses and openings is not too great.

In the typical verifications for single-family homes, the transverse forces arising are taken up by alternate-side nailing of the panels butt joints.

DIMENSIONING EXAMPLE:

<i>Horizontal traffic load:</i>	$p = 2.00 \text{ kN / m}^2$
<i>Building length:</i>	$l = 10.00 \text{ m}$
<i>Element length:</i>	$b = 2.00 \text{ m}$ (minimum length that should be applied for assembly as a slab)

$$M = p \times l^2 / 8 = 2.00 \times 10.00^2 / 8 = 25 \text{ kNm}$$

$$D = Z = 25 / 2 = 12.5 \text{ kN}$$

TRANSVERSE FORCE IN THE PANEL CONNECTION JOINT:

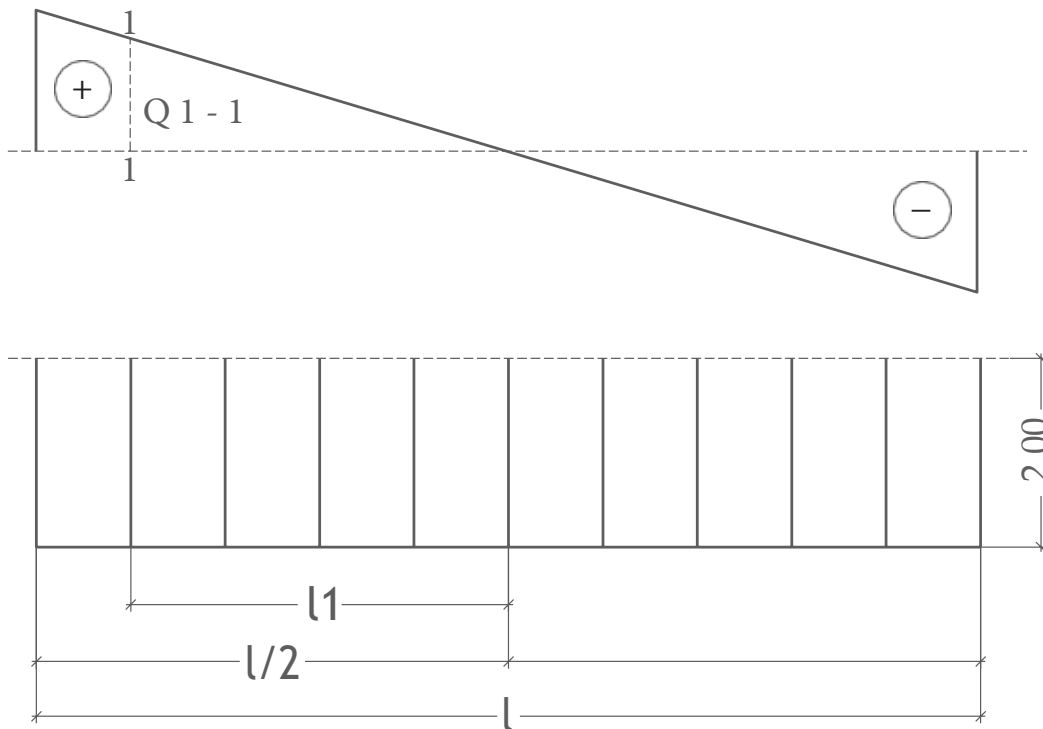

1st determination of the support force Q

$$Q = p \times l / 2 = 2 \times 10 / 2 = 10 \text{ kN}$$

2nd determination of the transverse force Q_{1-1} in the first element connection joint

$$Q_{1-1} = Q \times l_1 / (l / 2) = 10 \times 4 / (10 / 2) = 8 \text{ kN}$$

$$= 4 \text{ kN / m}$$

Assembly of the connection via diagonal, alternate-side nailing, offset by 90° Typically:

Round wire nails as machine nails $3.8 \times 100 \text{ mm}$ spaced at $e = 0.20 \text{ m}$

Permissible nail load until shearing off $Q_a = 0.36 \text{ kN}$

Required number of nails $n = Q_{1-1} / \text{perm. } Q_a = 4.0 / 0.525 = 7.62 \rightarrow 8 \text{ nails over one meter of length, evenly distributed.}$

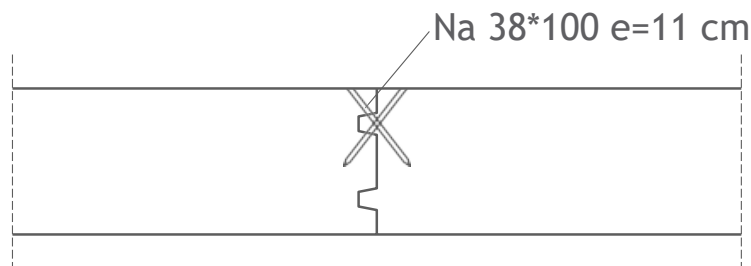

GLULAM TIMBER PANELS TRIMMING

DETAIL 4

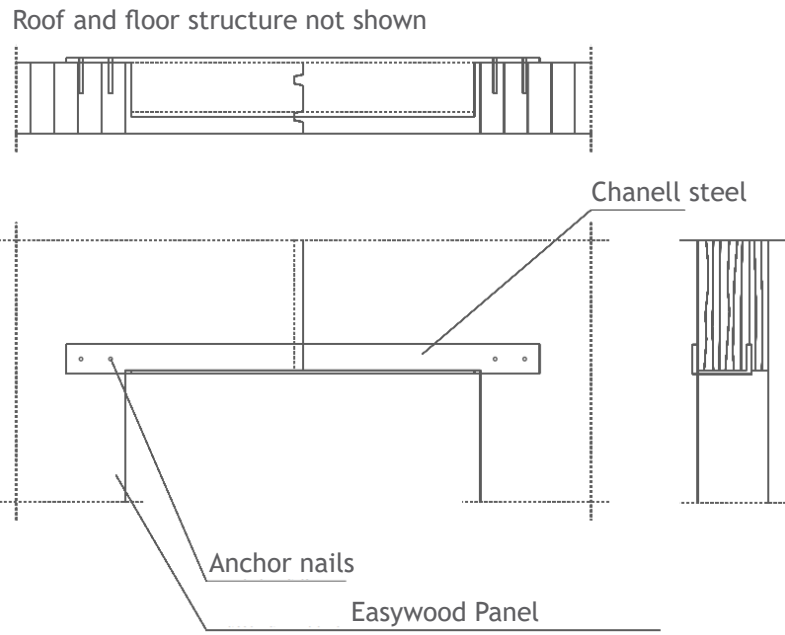

FLOOR PLATE TO WALL PANEL CONNECTION

DETAIL 5

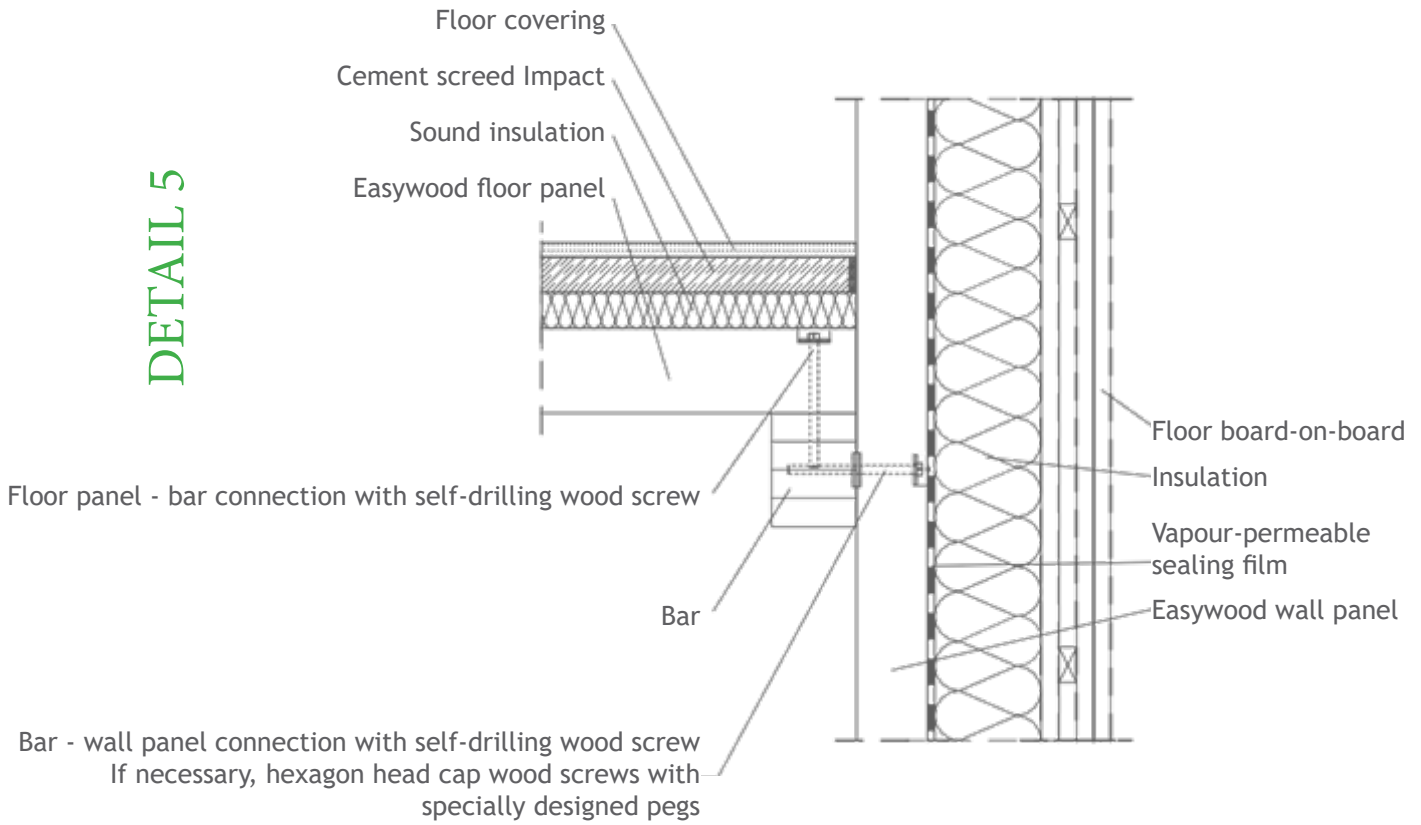

FLOOR PLATE TO WALL ELEMENT CONNECTION (OUTER WALL)

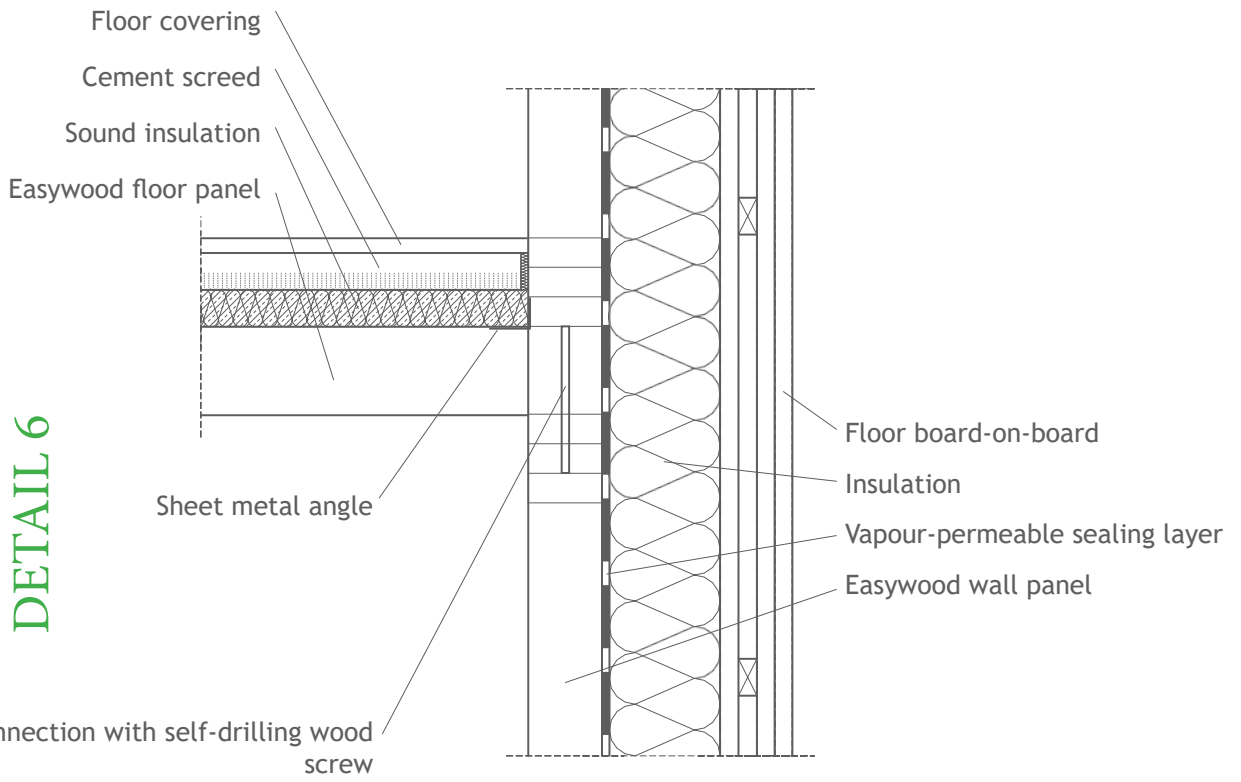

FLOOR PANEL TO WALL PANEL CONNECTION (INNER WALL)

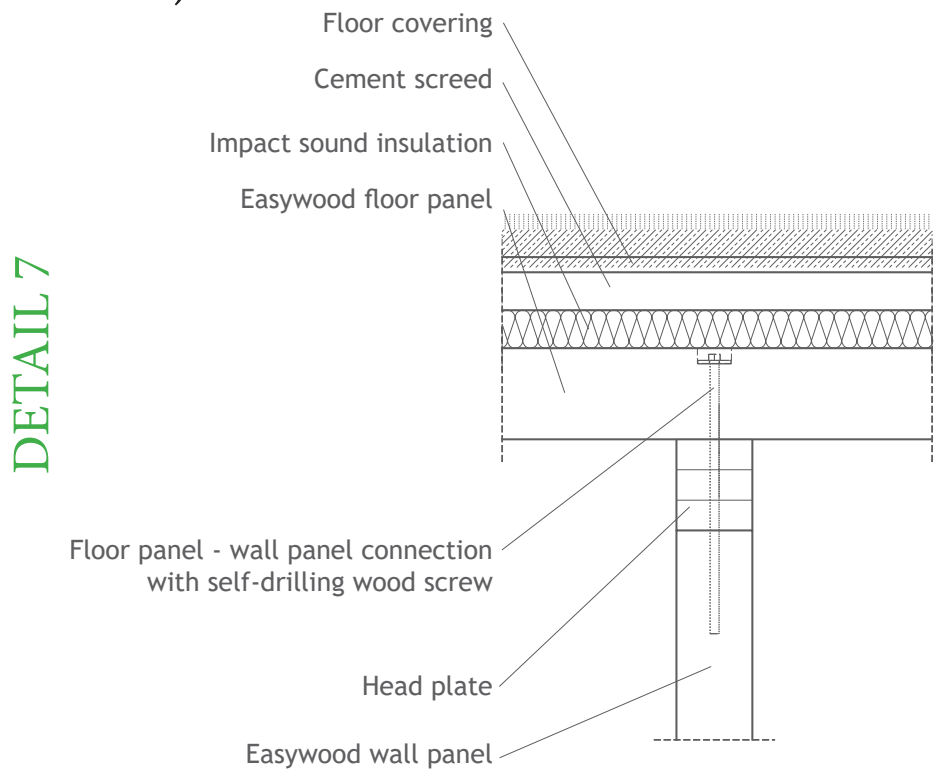

FLOOR PLATE - SOLID WALL CONNECTION

DETAIL 8

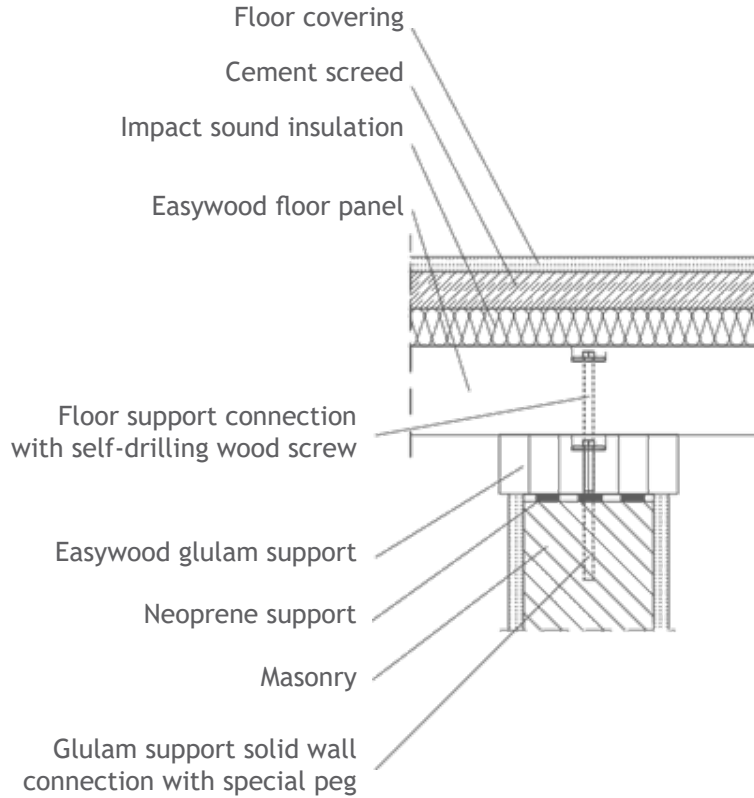

FLOOR ELEMENT - RING ANCHOR CONNECTION

DETAIL 9

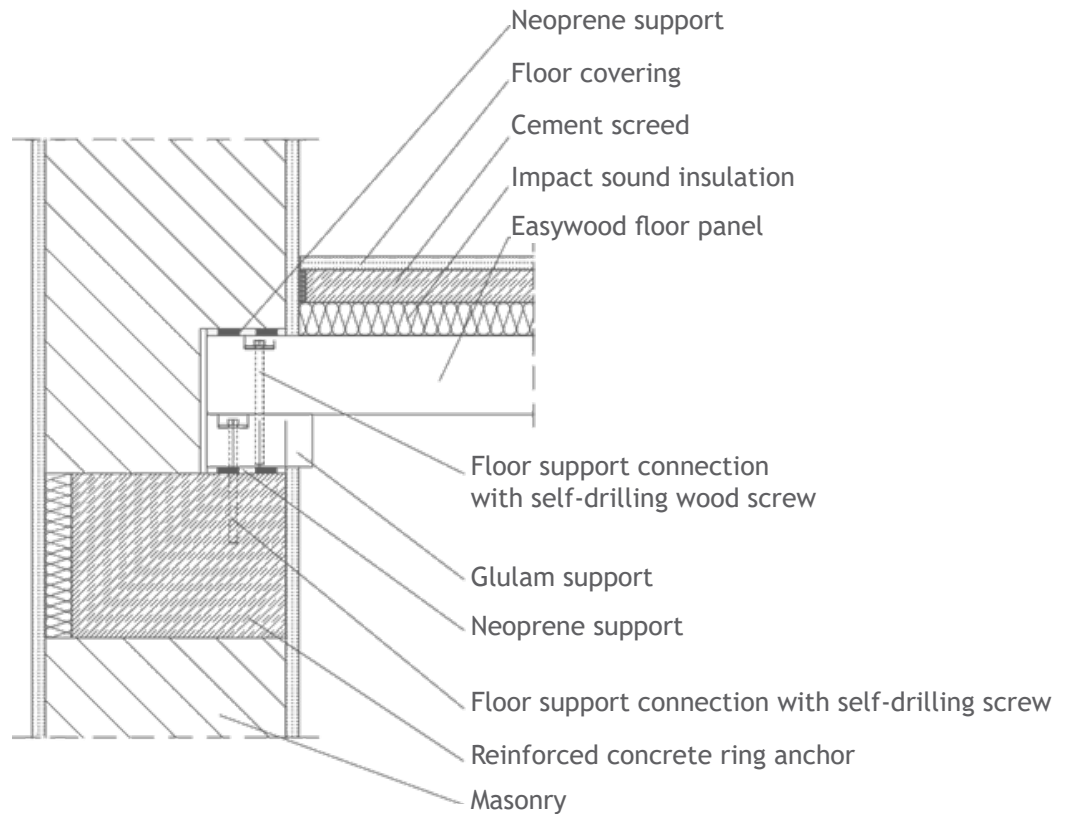

BINDING BEAM - RING ANCHOR CONNECTION

DETAIL 10

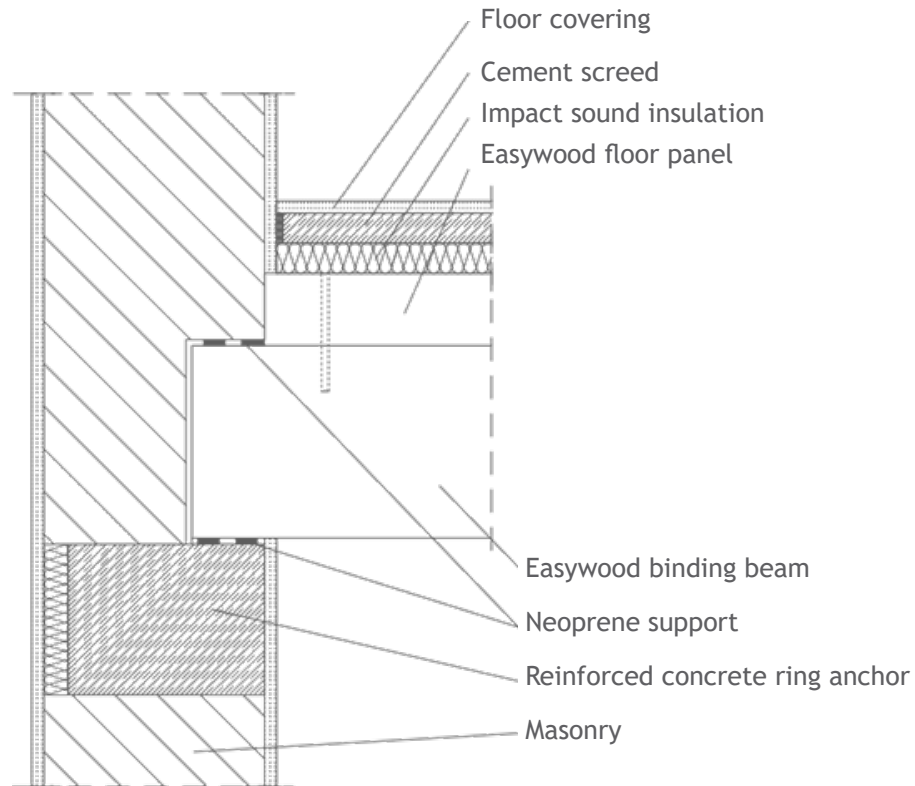

FLOOR PANEL - WOOD FRAME WALL CONNECTION

DETAIL 11

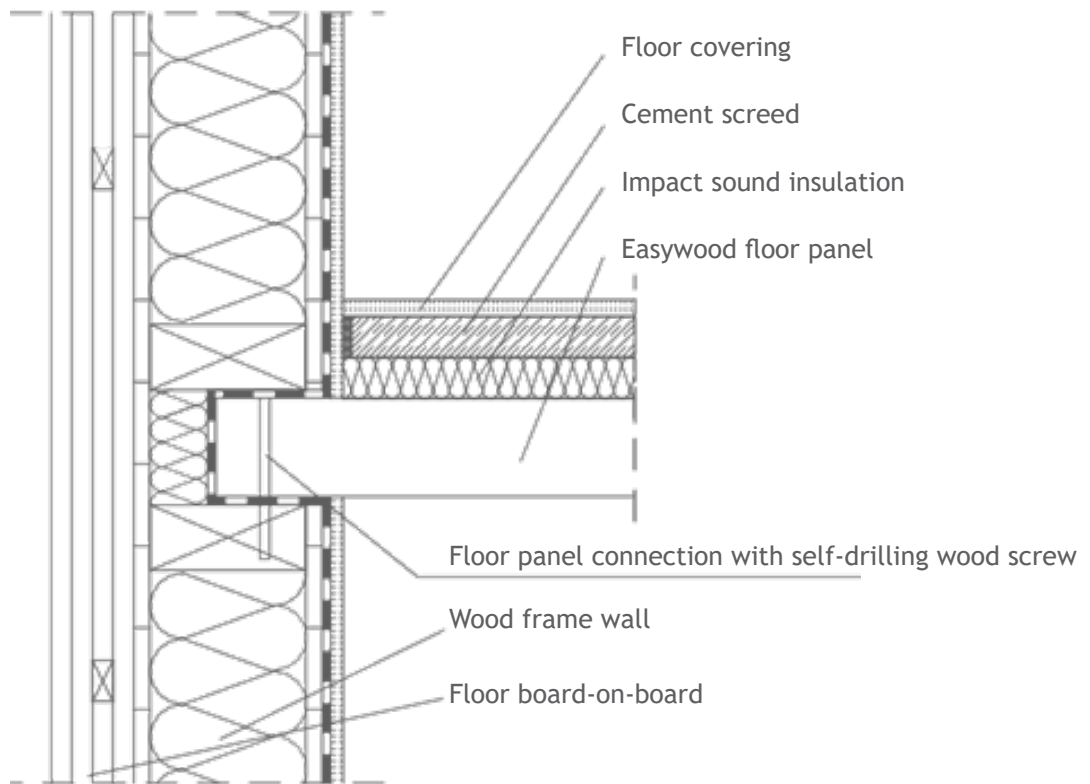

FLOOR PANEL TO WOOD FRAME WALL CONNECTION WITH INSTALLATION LEVEL

DETAIL 12

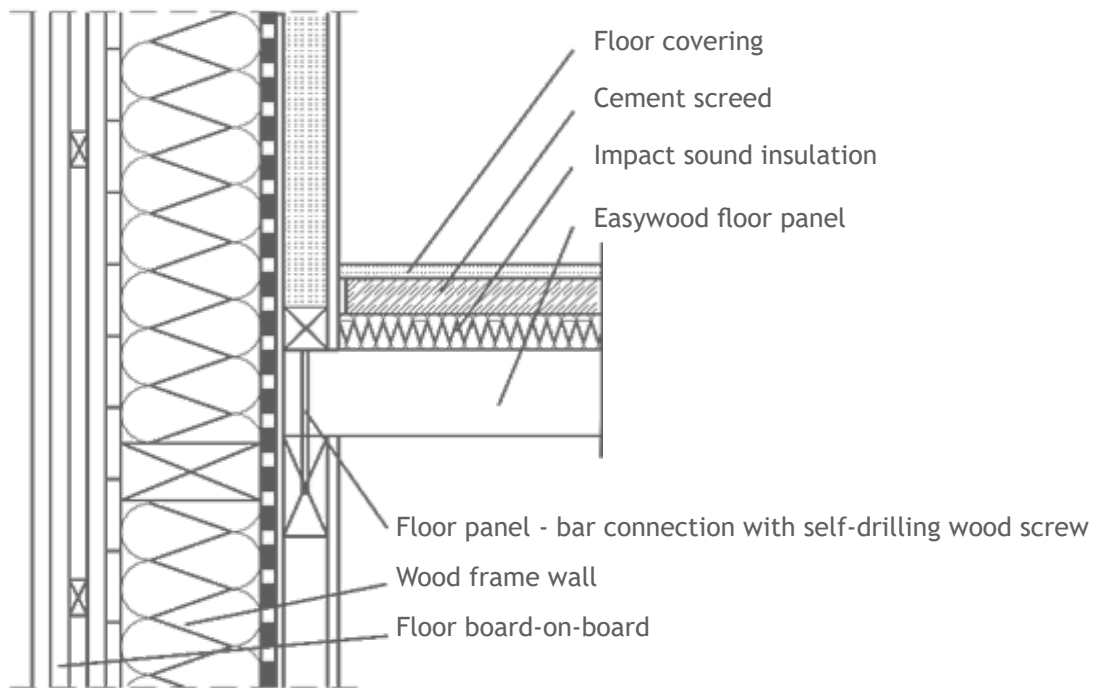

FLOOR PANEL TO WOOD FRAME WALL CONNECTION WITH SECONDARY - PRIMARY BEAM

DETAIL 13

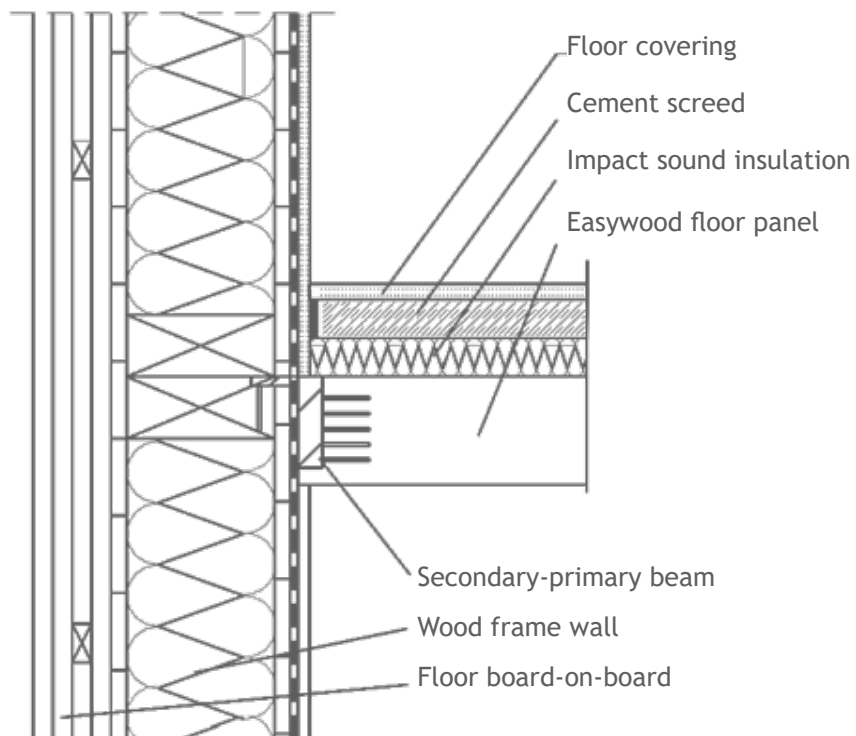

FLOOR PANEL - BINDING BEAM CONNECTION

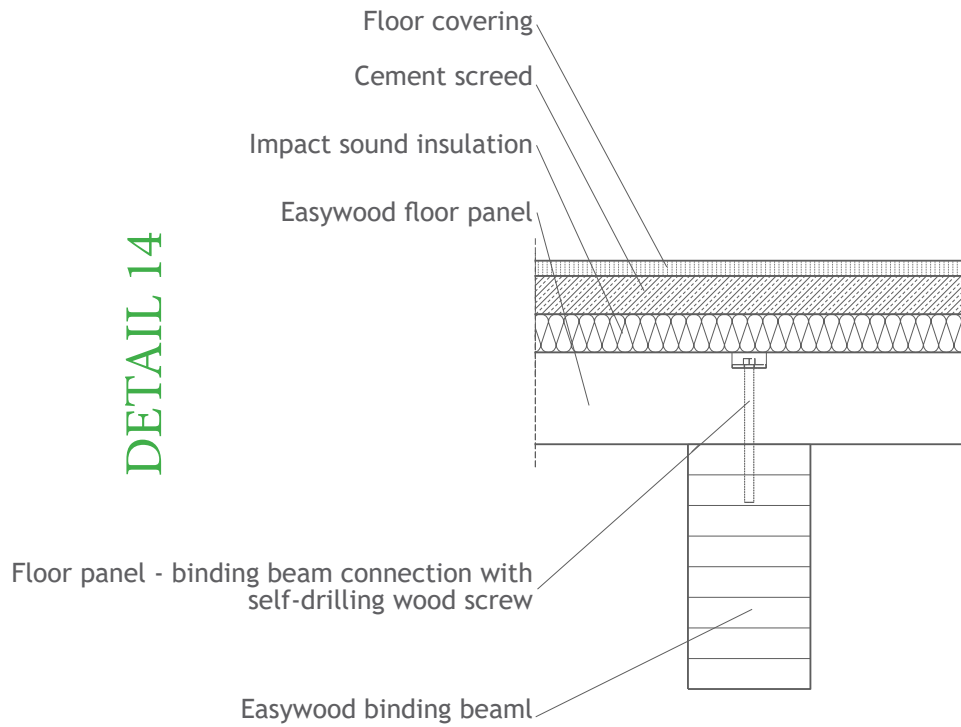

FLOOR PANEL - BINDING BEAM CONNECTION

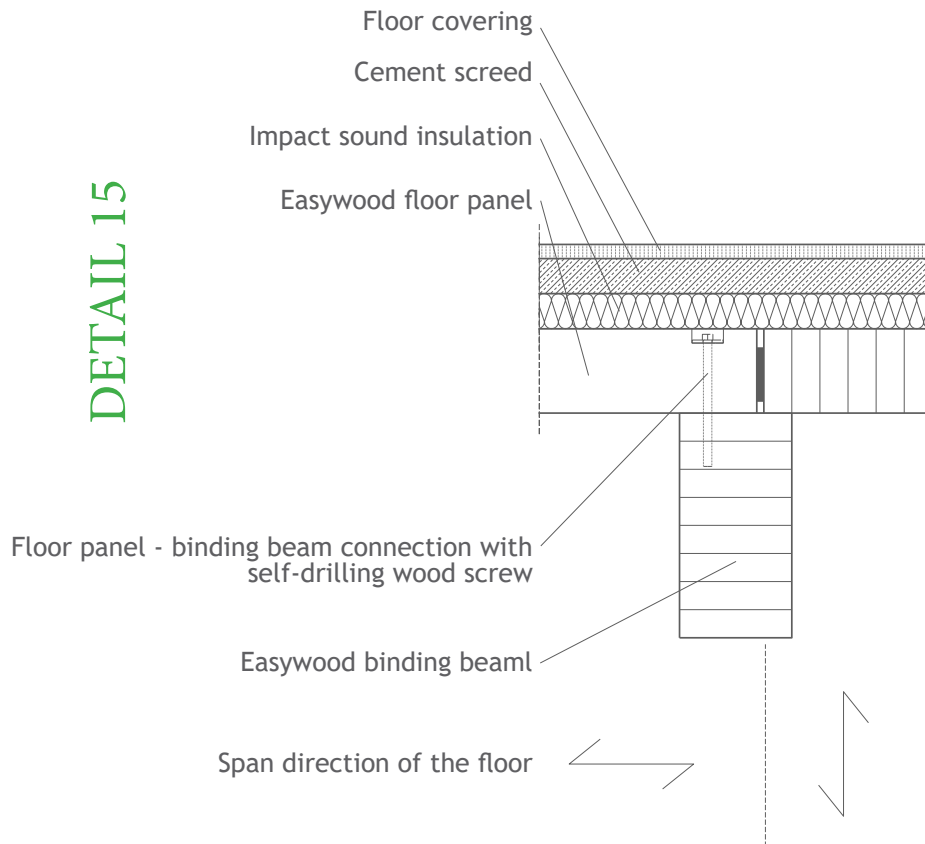

GLULAM TIMBER PANELS FLOOR

COST OVERVIEW

In addition to the attractive appearance and the comfortable room climate, costs are an important factor in the decision to use Easywood glulam timber floor panels. In this overview, we list the material and installation costs for our floor system as a guide for builders. This only represents a cost estimate. You should obtain a detailed offer.

EASYWOOD FLOOR PANELS

Material costs for glulam floor panels; $t = 12$ cm:

Material costs for glulam flooring sleepers, etc.: $w/h = 8/16$ cm

Material costs for hexagon head cap wood screws/express anchor:

Assembly / trimming costs for glulam floor panels:

Additional cost benefits should be considered

- Time savings due to immediate starting of subsequent work. Reinforced concrete floors require a long curing time.
- Freedom of movement is ensured within the rooms below. For reinforced concrete floors, time must be planned for the curing of additional supports.
- No additional moisture is produced during installation. Approx. 170 litres of water per m^3 are required for creating reinforced concrete floors. This corresponds to 2,720 litres of water for a 16 cm thick floor with an area of $100 m^2$. The moisture is returned to the environment during curing.
- The bottom side of the Easywood glulam panels is very decorative. Reinforced concrete floors generate additional costs for levelling and covering work.

GLULAM TIMBER PANELS WALL

Glulam timber panels can be used as load-bearing and non-load-bearing walls. The butt joints of the glulam timber panels run vertically. The individual components are connected with nails or screws as well as the usual shaped sheet metal parts. The wall thickness is generally 10 cm. This allows for supporting of very high loads, assuming normal room heights.

The wall system is vapour-permeable, meaning that a certain vapour pressure exists both inside the building and outside; the relative humidity. If the relative humidity inside is the same as the relative humidity outside, they are in equilibrium. If the relative humidity differs, a vapour pressure gradient exists.

The vapour pressure shifts to the lower pressure side of the building component, i.e. it diffuses. The flow to establish equilibrium is called diffusion. In vapour-permeable systems, a light resistance against this vapour pressure is generated by the installed materials.

If the humidity inside is high, meaning a high vapour pressure, the air attempts to achieve equilibrium with the low vapour pressure on the outside. This is a very slow process that should not be misunderstood as "breathing" by the wall; rather, it leads to controlled drying out of the wall from the inside to the outside.

In the case of the wall described below, the glulam panels with a material thickness of 10 cm have an sd value of 4.00 m. The vapour seal layer (vapour barrier) has an sd value of 2.00 m, and the vapour-permeable insulation (ideally soft wood fibre) with a material thickness of 16 cm has an sd value of 0.16 m

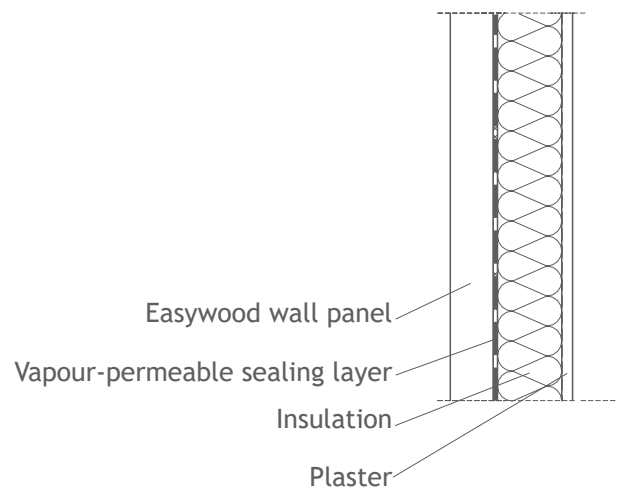
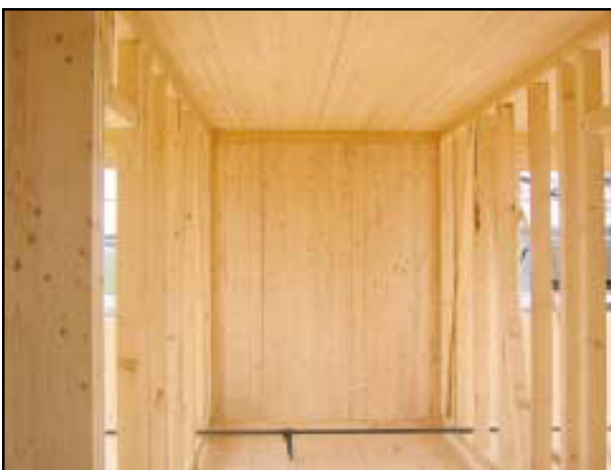

WALL ELEMENTS CORNER CONNECTION

DETAIL 16

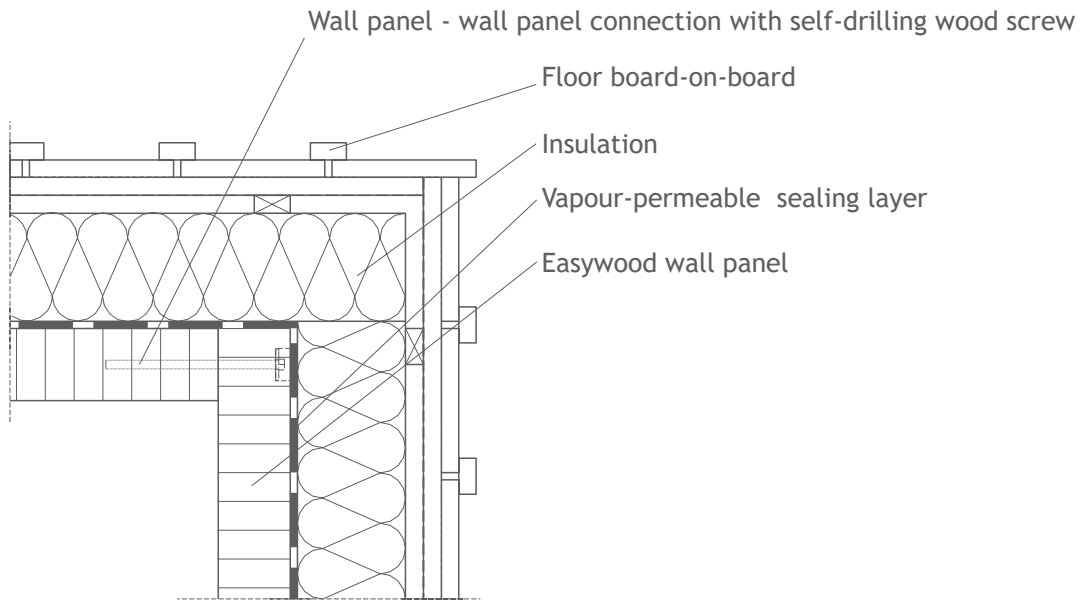

WALL ELEMENTS CONNECTION (INSIDE WALL)

DETAIL 17

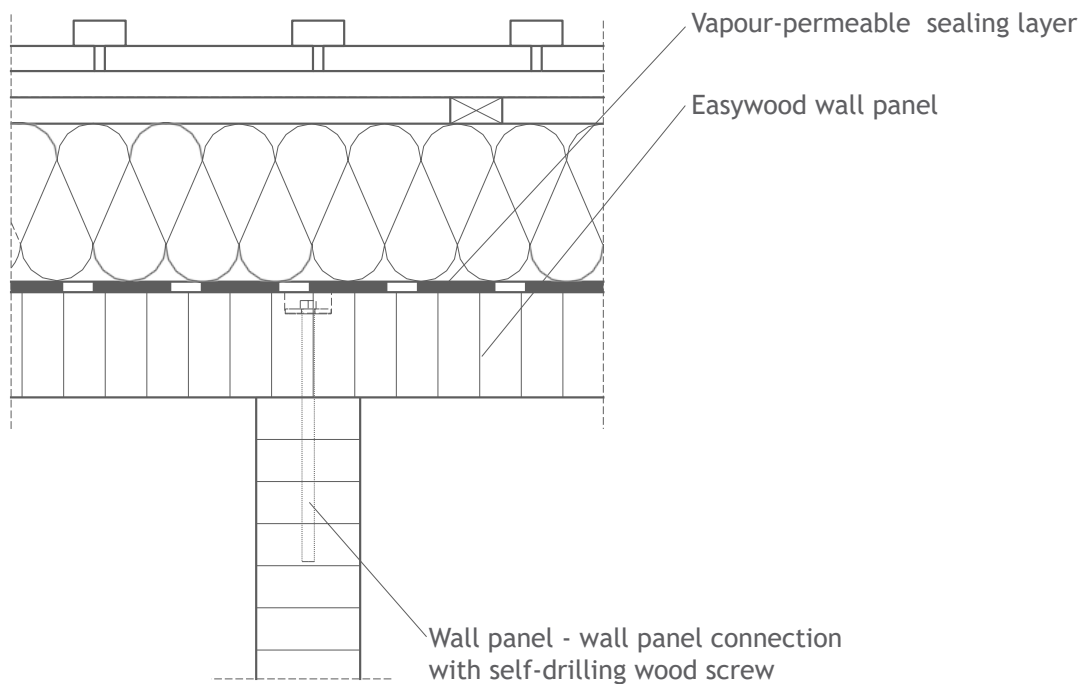

WALL PANEL - FLOOR PLATE CONNECTION

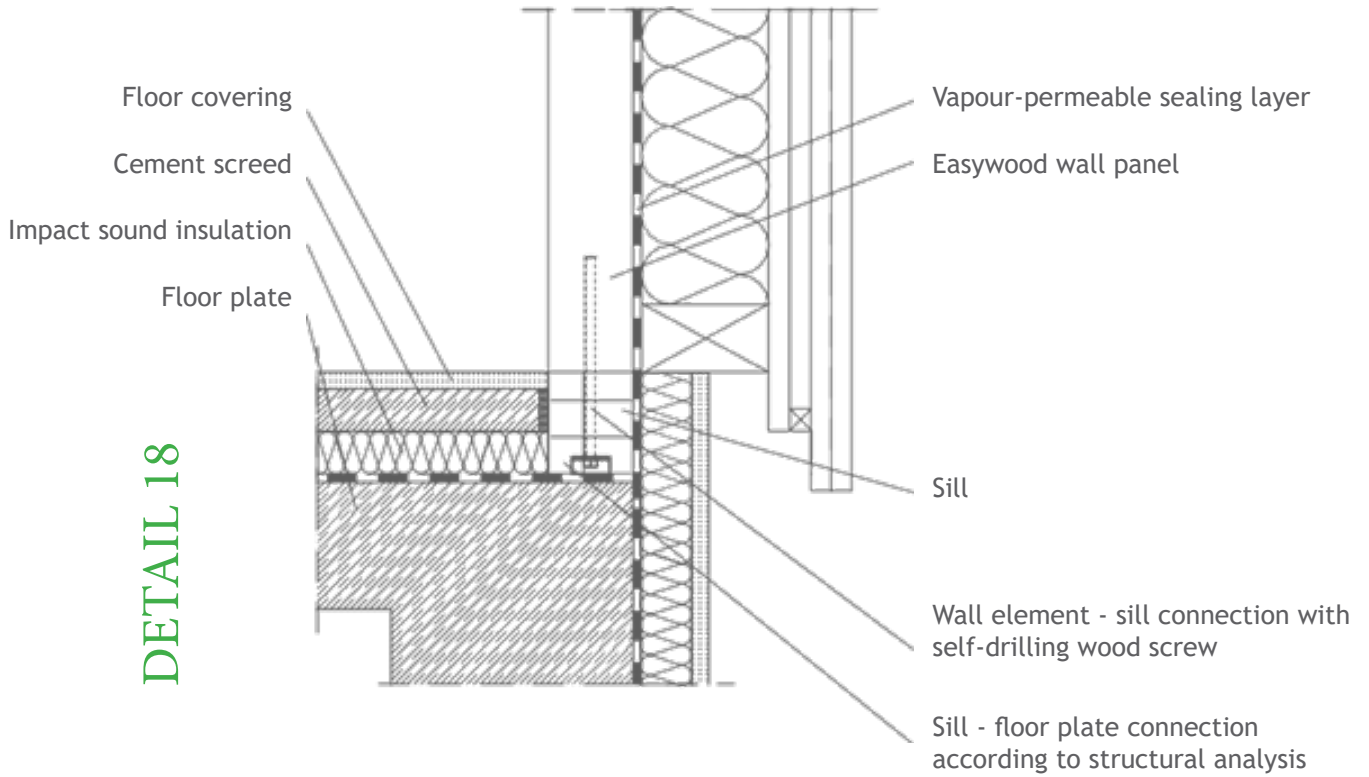

WALL PANEL - HEAD PLATE CONNECTION WITH APERTURE PLATE

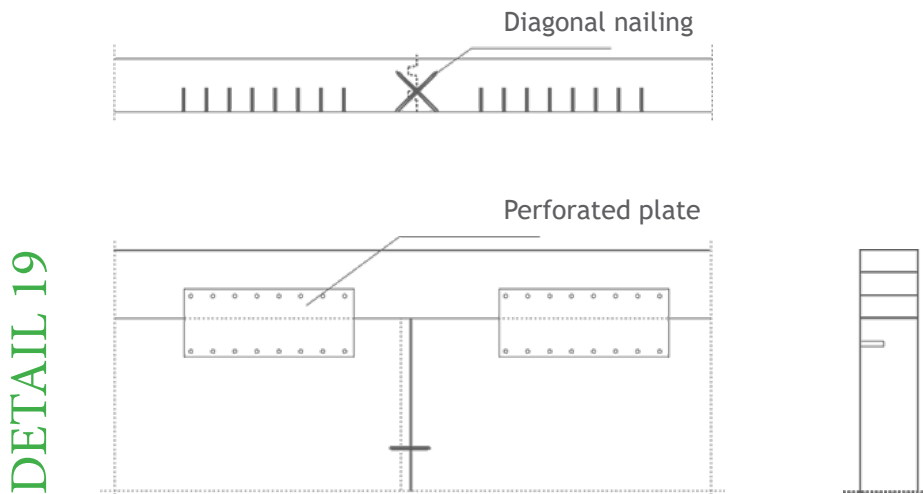

WALL PANEL - HEAD PLATE CONNECTION WITH SELF DRILLING WOOD SCREWS

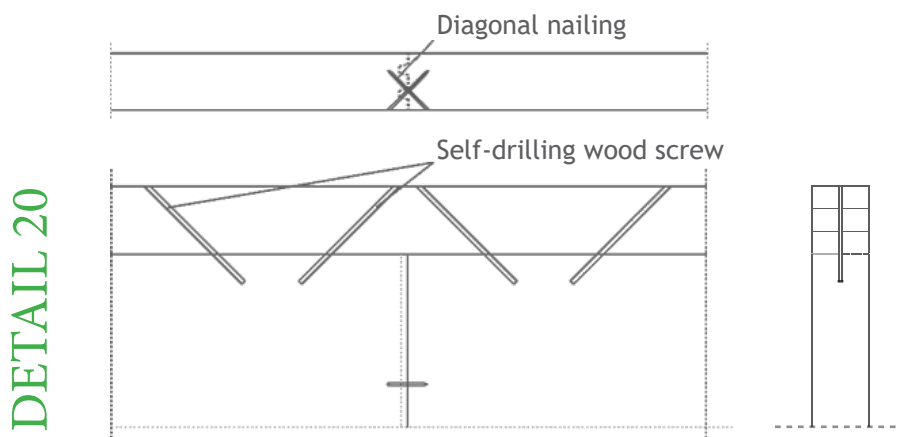

COST OVERVIEW

Wall elements are a solid and dry alternative to masonry walls. This only represents a cost estimate. You should obtain a detailed offer. In addition, the thermal insulation, seal layer and outside wall covering (plaster, boarding or brick facing) must also be calculated into the costs.

EASYWOOD WALL PANELS

Material costs for glulam wall panels; $t = 10$ cm:

Material costs for shaped sheet metal parts, screws, etc.:

Assembly / trimming costs for glulam wall panels:

PLEASE NOTE

The outer layers of the panels may take up moisture during the construction phase. In event of heavy water exposure (e.g. rainfall or construction water), an extreme rise in the wood moisture can occur. In exceptional cases, this can change the volume of the glulam panel enough to cause displacement and expansion forces acting on the connected structures. For this reason, the panels must be protected against direct moisture exposure by covering them with plastic. Excess water must be removed with air dehumidifiers to slowly reduce the wood moisture. All information corresponds to the current level of technical knowledge. SIA "Easywood" does not accept any liability. This also applies to print errors and subsequent changes to technical information.

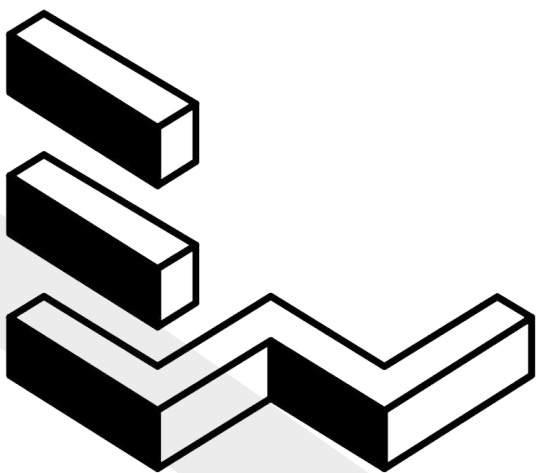

E A S Y W O O D

**GLUED LAMINATED
TIMBER**

Mežrūpnieku iela 6a
Jēkabpils, Latvija
www.easywood.lv

